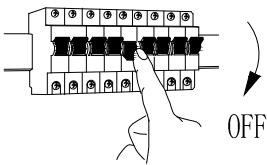
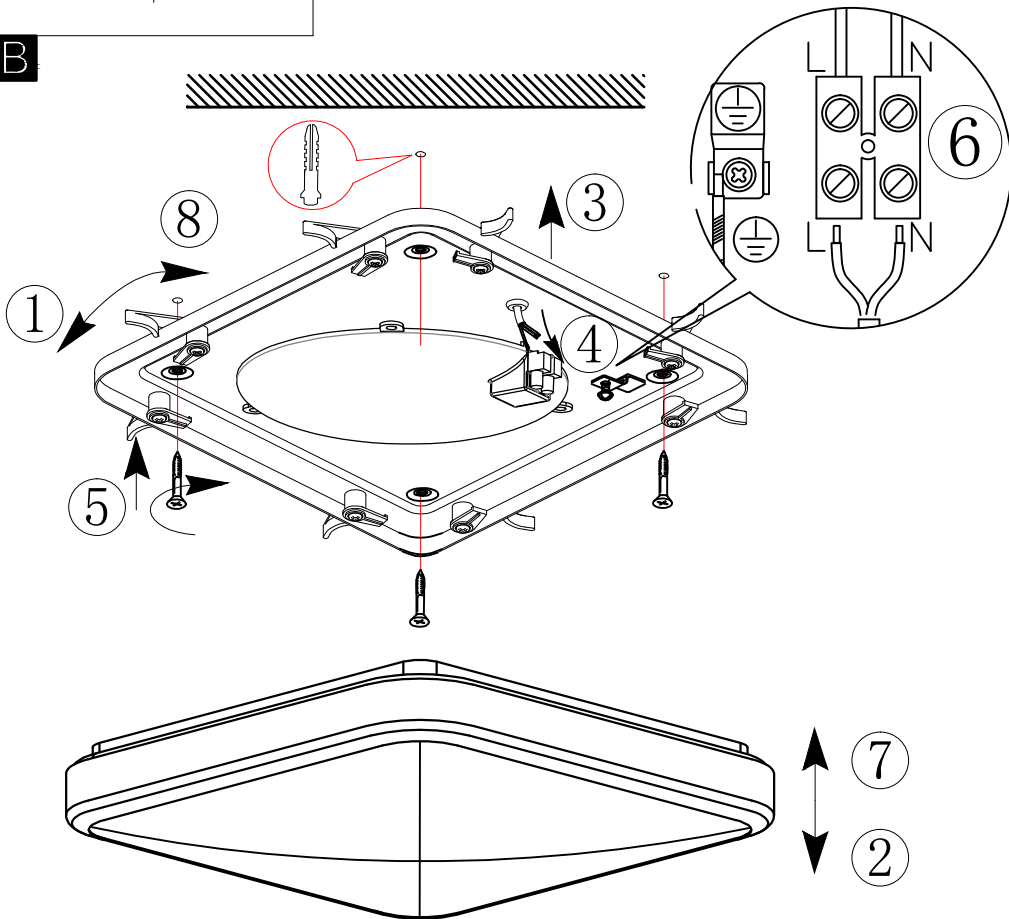
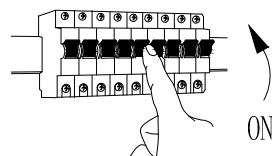

**A****B****C**

BLA96229

www.eglo.com