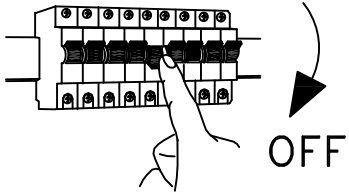
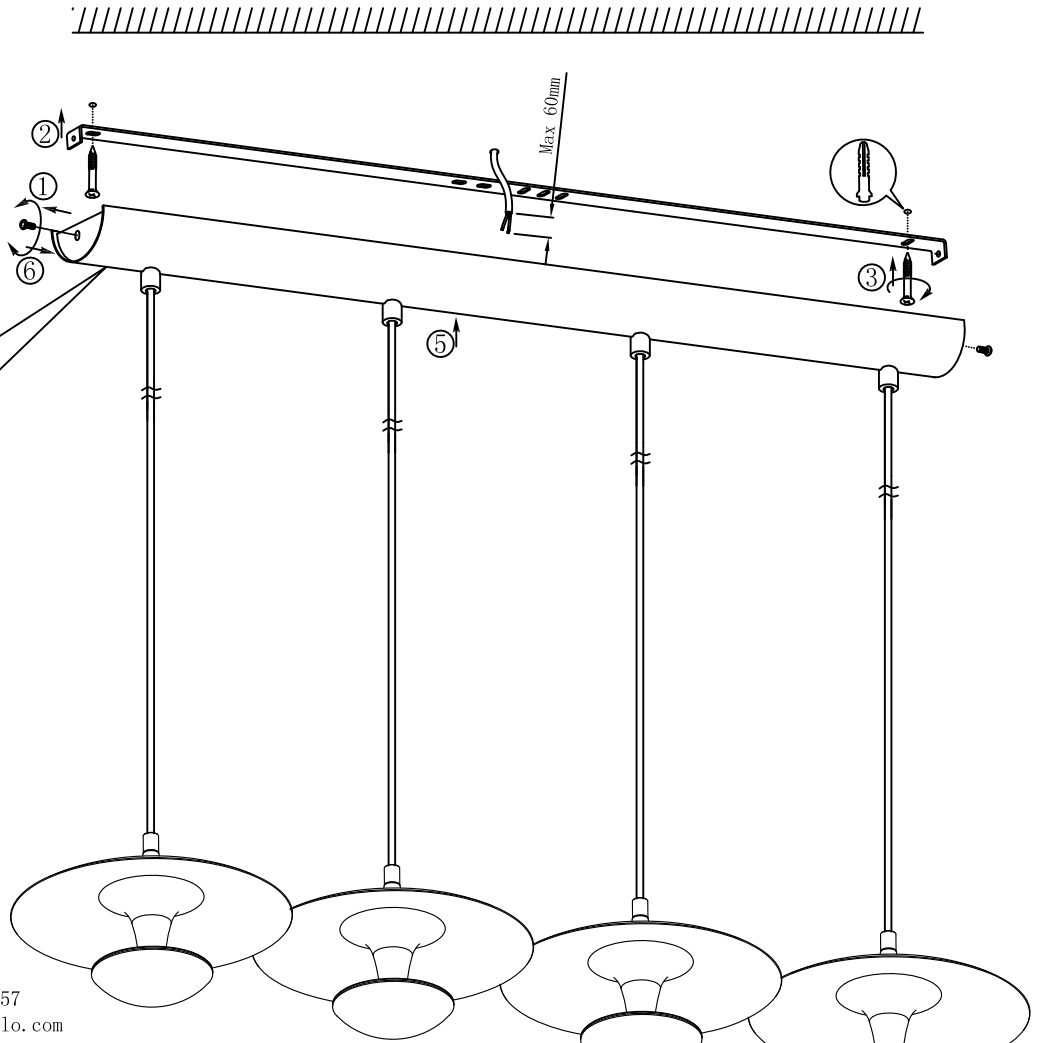
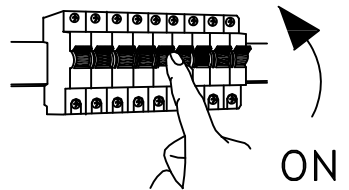

**A****B****C**

BLA95957  
www.eglo.com