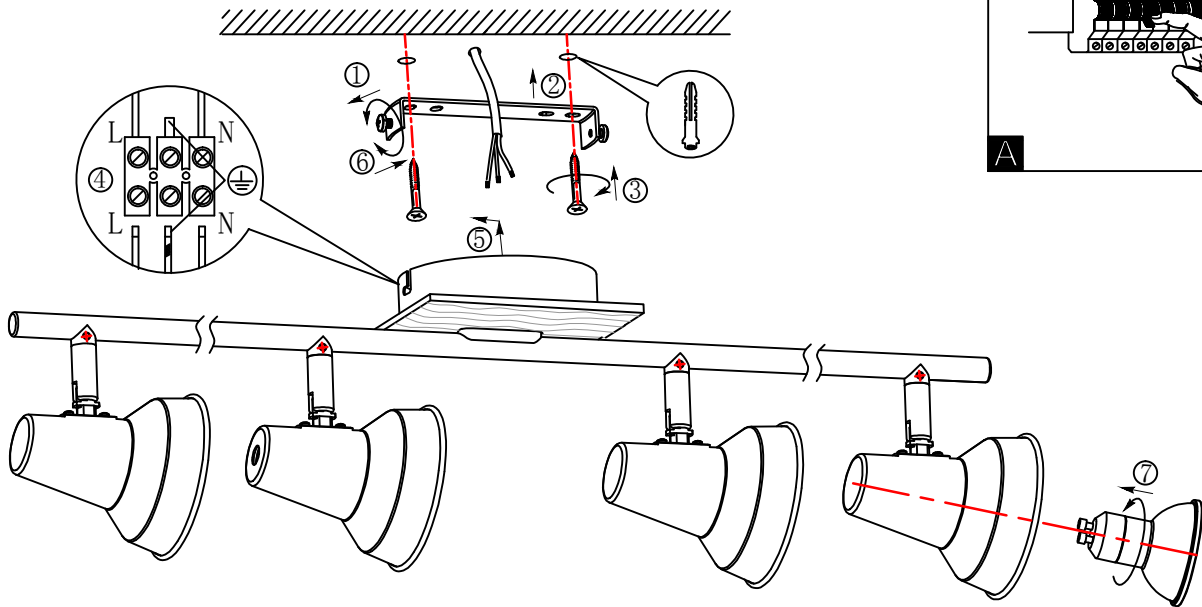
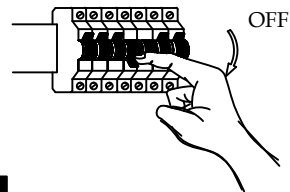
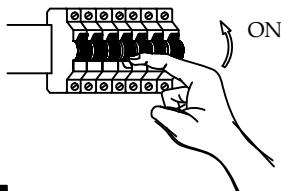

**B****A****C**

BLA95645

www.eglo.com