

**C**

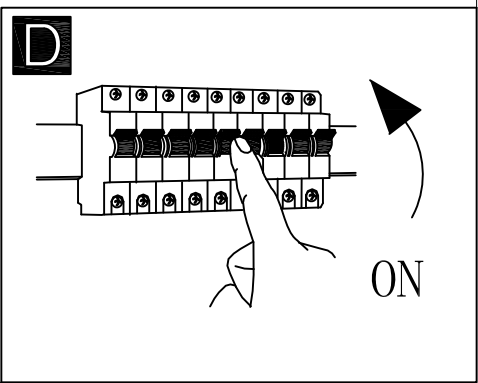

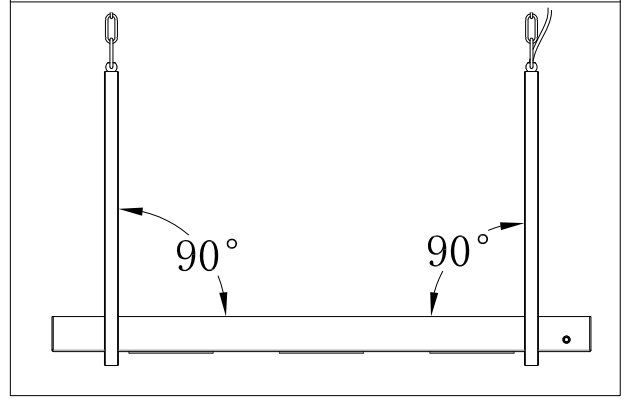

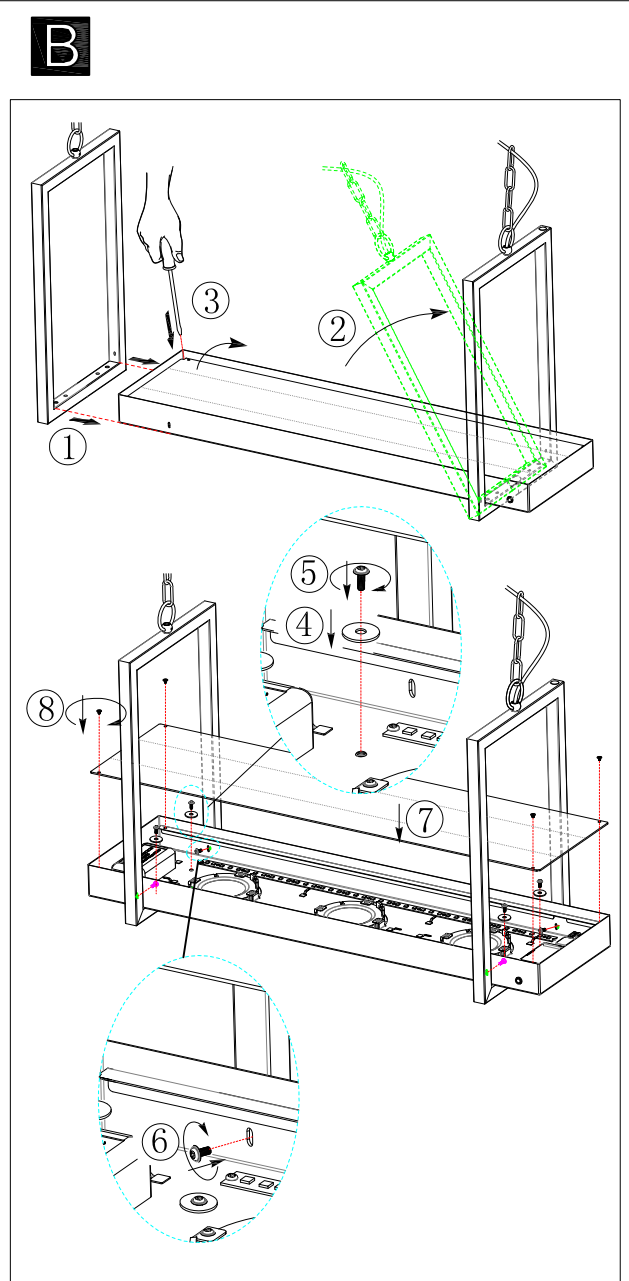

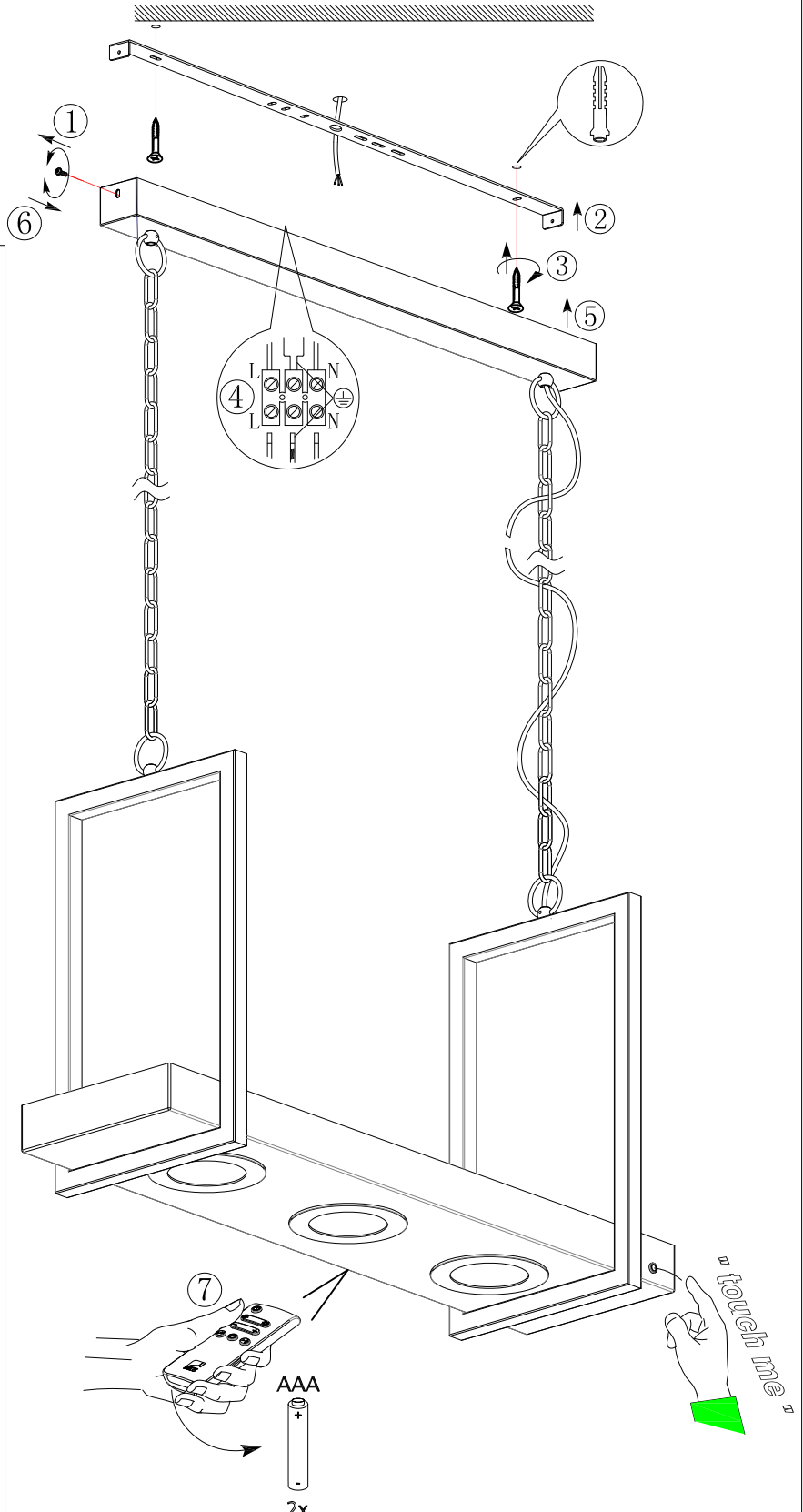
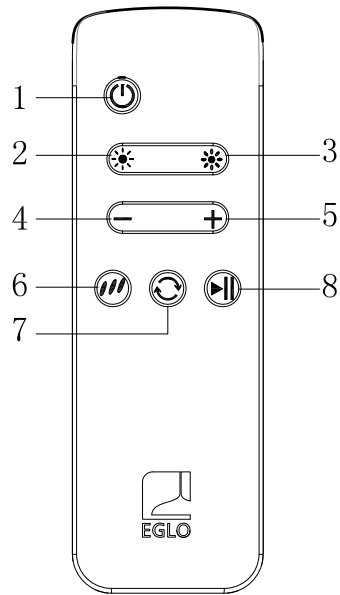

1.  POWER ON/OFF

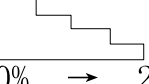
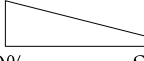
2.  RGB ON/OFF

3.  W ON/OFF

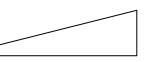
4.  W-   
 press:  100% → 20%   
 hold:  100% → 20%

5.  W+   
 press:  20% → 100%   
 hold:  20% → 100%

6.  RGB R G B R G . . . .

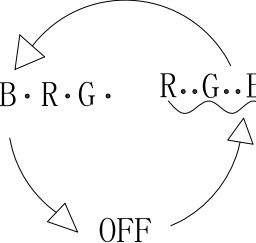
7.  RGB R · G · B · R · G · R · · G · · B · · R · · G · ·   

8.  RGB R · · G · · B · · R · · G · ·   
